









Another Approach









① Existing Technology

- Embedded bitmaps
- HTML Text
- MathML

	HTML Text	Images	Plugins & Applets
<i>Quality</i>			
<i>Resolution</i>			
<i>Document Size</i>			

Approach for Displaying Mathematics on the Web

Dominique Broeglin, Stéphane Lavirotte, Peter
Mainline Project (mainline.essi.fr)
Laboratoire I3S, Sophia-Antipolis, France

Applets	MathML plugin	SVG
)		
)		
)		
		

Web: MathML Content to SVG

for Sander

e

↗ In HTML

$$r(t) = A \left(1 - \frac{e^{-\gamma t} \sin(\omega \sqrt{1-m^2} t - \Psi)}{\sqrt{1-m^2}} \right)$$

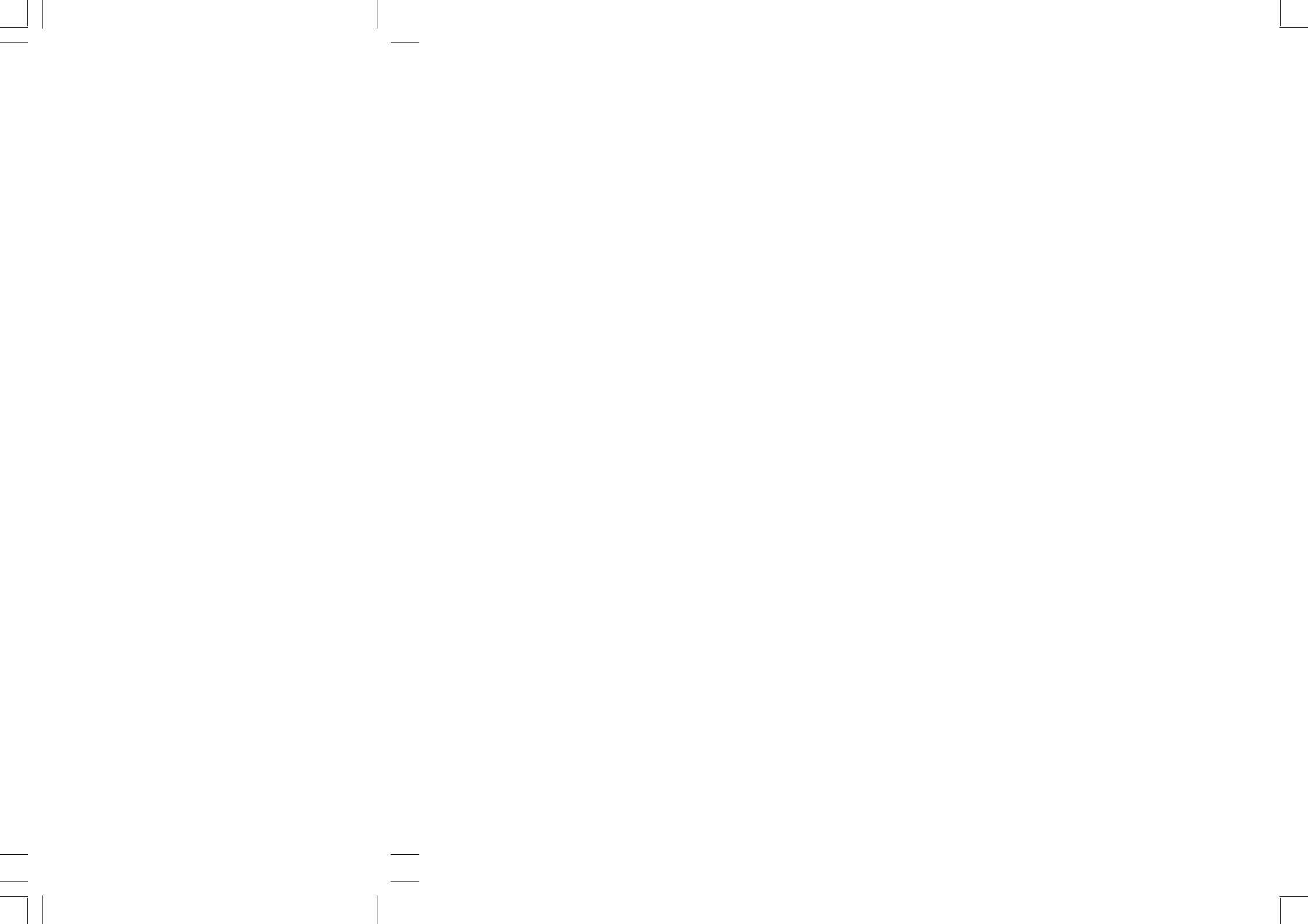

- MathML
- Plugins and applets
- SVG

			
<i>Interactivity</i>			
<i>Standard Format</i>			
<i>Fonts</i>			

② MathML

- Emerging representation standard
- MathML content
- MathML presentation
- How to display?
 - Plugins and applets
 - SVG

③ Trai

	☺	☺
☺	☹	☺
☹	☺	☹
☹	☹	☺

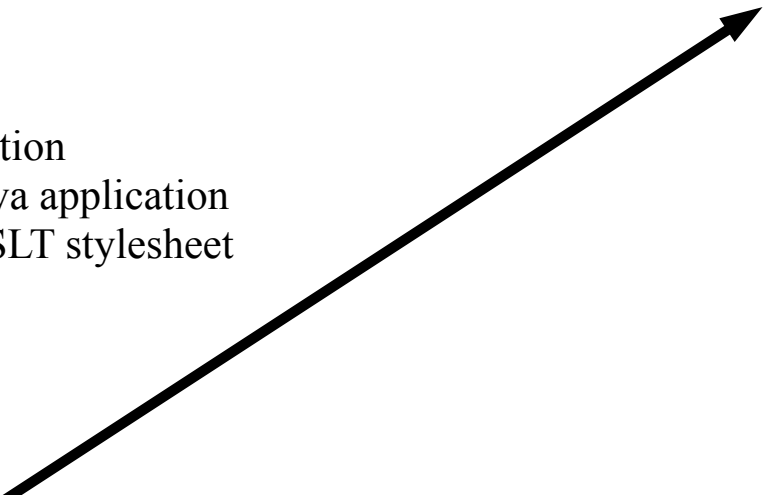

SVG

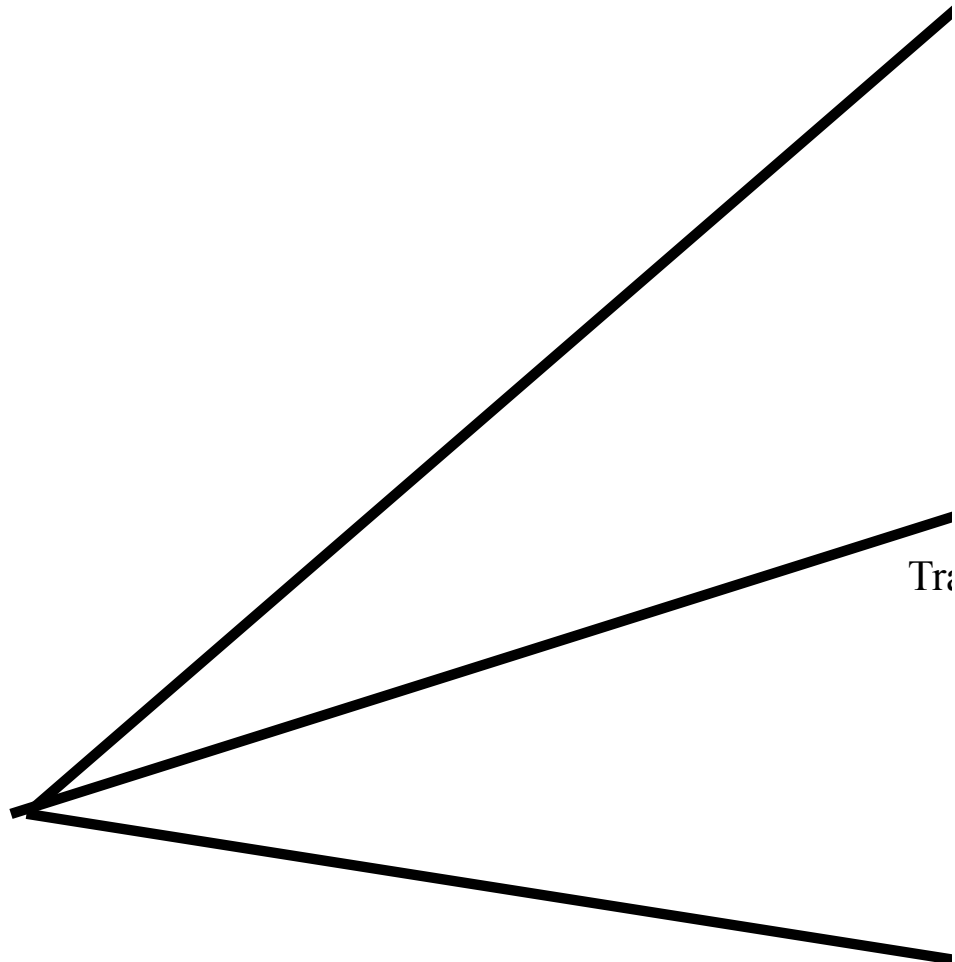

Transformation

- Java application
- XSLT stylesheet

Tr

In HTML

\

√ l - m

/

In PDF

Transformation

- Formatting object

In composite SVG diagram

- Into HTML as above
- Into PDF as above

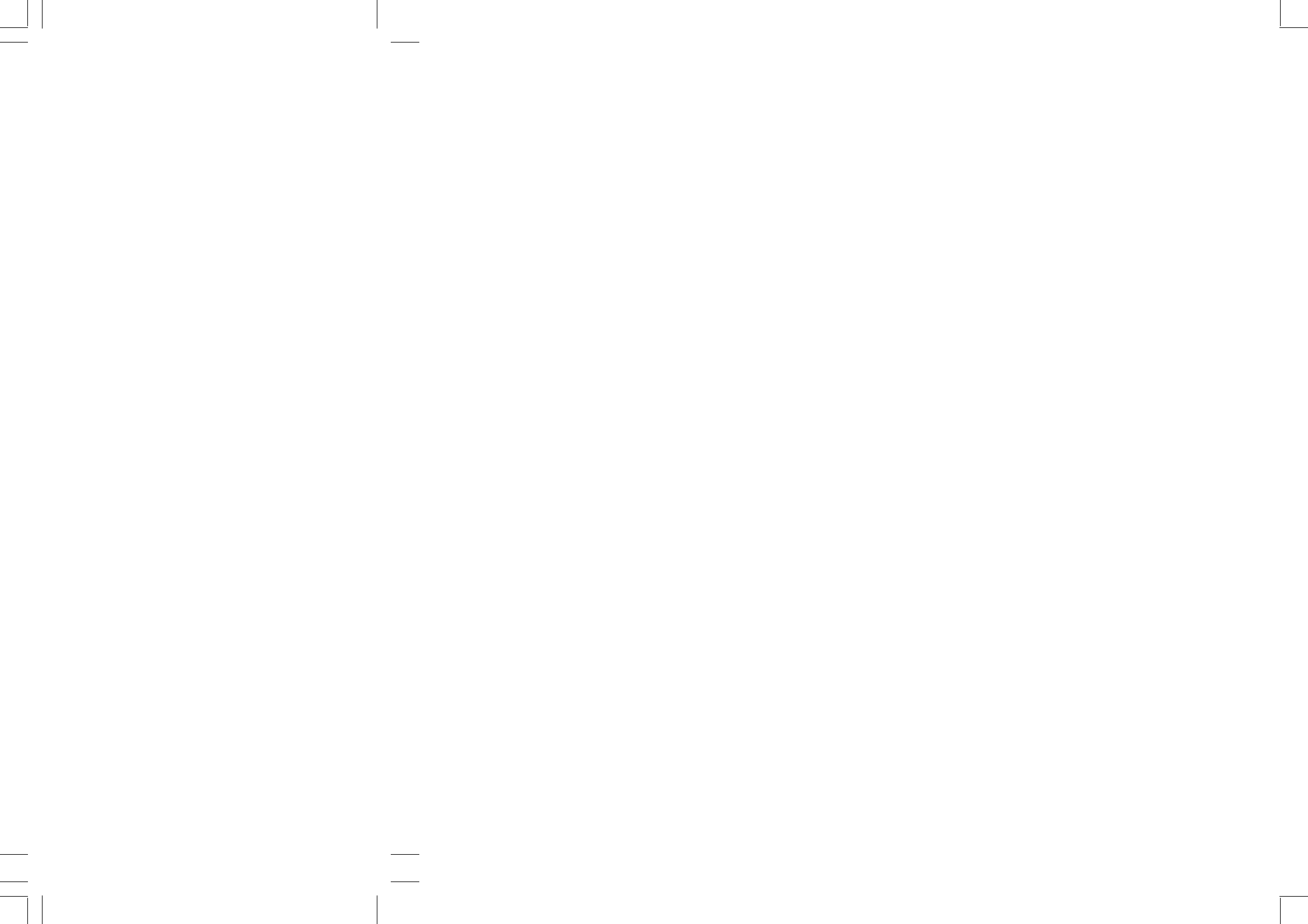

- Plugins and applets
- SVG

Content MathML

```
<math>
...
  <apply>
    <root/>
    <apply>
      <minus/><cn>1</cn>
      <apply>
        <power/><ci>m</ci><cn>2</cn>
      </apply>
    </apply>
  </apply>
...
</math>
```

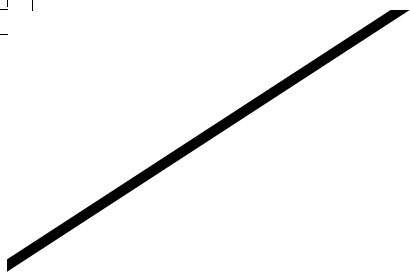

n>2</cn>

E(p)

[
.
.]

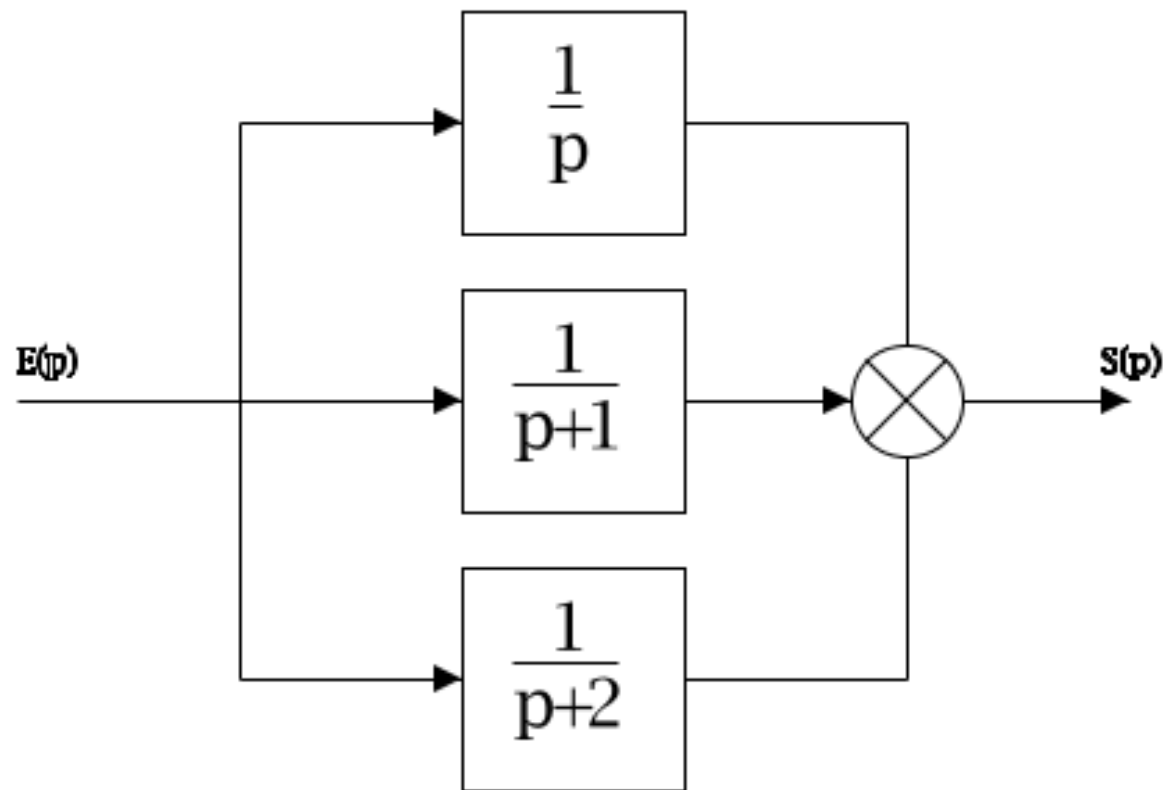

$$\frac{S(p)}{E(p)} = \frac{3p^2 + 6p + 2}{p(p+1)(p+2)}$$

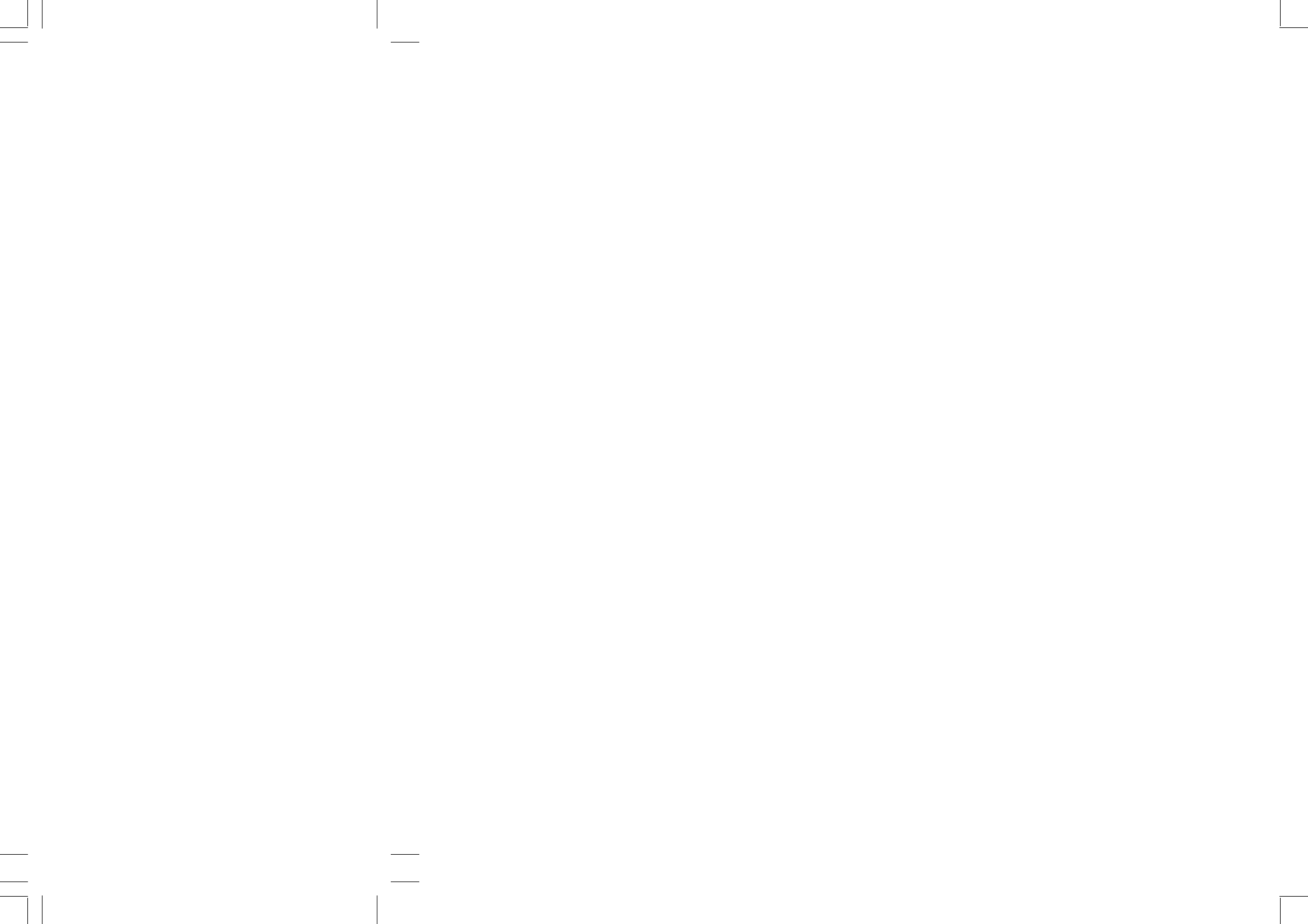





④ For more detailed information, see:
<http://mainline.essi.fr/wiki/bin/view/Fixide>

ixidea/WebHome